



Altair **Inspire**™
Cast

Streamlined Casting Simulation

Altair Inspire Cast offers complete casting simulation in 5 easy steps through a highly intuitive user experience, catering to beginners and experts alike.

Fast, Easy, Accurate, and Affordable

Powerful and Accurate Casting Simulation without the Complexity

Altair Inspire Cast was developed with its end users in mind. We strive to make casting simulation as easy as possible by using 'foundryman's language' in our software. Every word in the interface comes from the casting process world. Not only is the software incredibly easy to use, it is also highly accurate and powerful. Get started with Altair Inspire Cast today to further investigate and explore your casting process with just a few clicks.



“Using Altair Inspire Cast for casting simulation allows us to quickly perform iterative improvements on our projects, reducing the time necessary to achieve an optimal casting process. This reduction in design time is reflected in the reduction of tooling development costs.”

Eder de Sousa
Industria de Moldes y Matrices

“With Altair Inspire Cast, we optimized the mold design and achieved greater reliability for aluminum pressure die casting.”

Dionei Concer
Fabrica Brasileira de Moldes

Simulation-Driven Casting

Complete Casting Process Simulation in 5 Easy Steps



Import Geometry



Define Ingate(s)



Set-Up

Improve Quality

Altair Inspire Cast allows the user to enhance and optimize their manufactured components avoiding typical casting defects such as air entrapment, porosity, cold shuts, etc.

Altair Inspire Cast Provides an Intuitive Workflow to Set Up Simulations for:

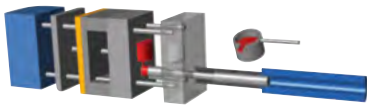

High Pressure Die Casting

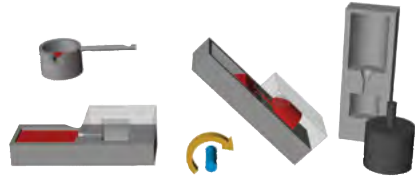

Gravity Tilt Pouring

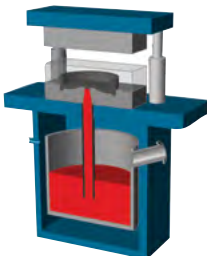

Low Pressure Die Casting

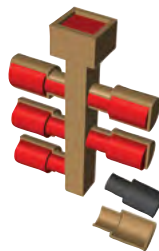

Investment Casting

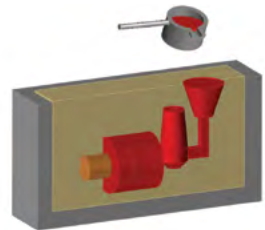

Gravity Sand and Die Casting



Run



Analyze



Cast

Limit Iterations

Altair Inspire Cast enables the use of simulation early in the design process, helping users avoid costly iterations between design and production.

Intuitive Component Creation

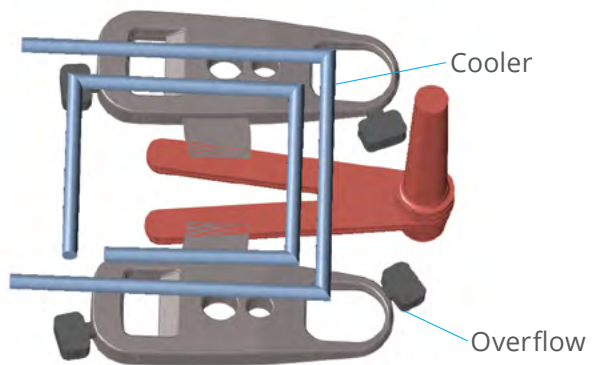
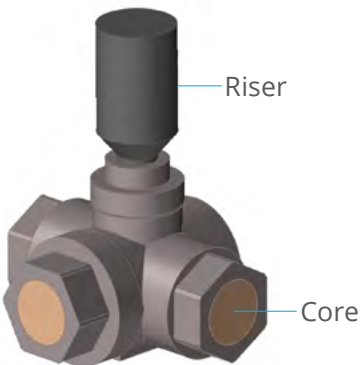

Additional Components

Core | Chiller | Riser | Sleeve | Overflow | Mold | Cooler

Powerful Result Visualization

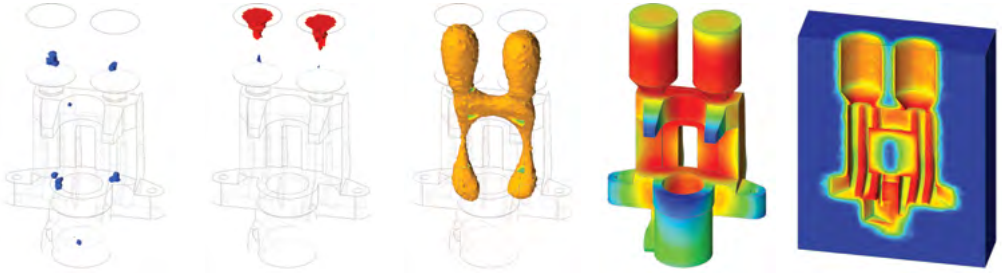

Additional Post-Processing for Detailed Analysis

Flow Front | Cold Shuts | Cold Unions | Air Entrapment | Mold Erosion | Filling Evolution | Liquid & Solid Fraction
Gas Porosity | Solidification Modulus | Riser Optimization | Turbulence | Mold Degradation

Start Today

Altair Inspire Cast was developed with usability in mind. Save time and money, there is no need to invest in extensive training or expert staff. Get started today and run complex casting simulations in 5 easy steps.

Accurate Defect Prediction

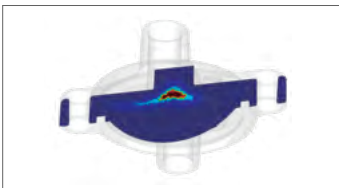

Fast and accurate defect prediction including shrinkage porosity, cold shuts, mold degradation, and more.



“Altair Inspire Cast is **extremely easy to learn**, as it guides you through the set-up process. With **minimal knowledge of castings**, you can generate **meaningful data your first day**. We use it to quickly evaluate casting for porosity and other defects as part of our quoting process. As we proceed with the projects into production, we use Altair Inspire Cast to help **optimize the design and location of gates and runners**.”

Steve Fetsko

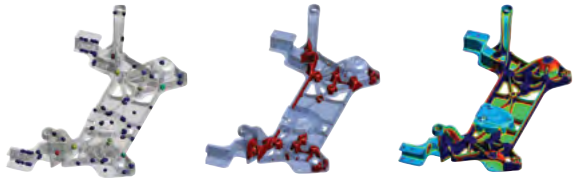

Altair Inspire Cast Benefits

Beginners as well as expert users can quickly and effectively avoid casting defects such as air entrapment, porosity, cold shuts, and more. An innovative, user friendly experience allows simulations to be completed in 5 easy steps with guided templates for most casting processes to help design better products, increase manufacturing quality and profitability with minimal training.

Design Better Products

- Quickly evaluate 'castability'
- Visualize solidification to optimize ingate location
- Simulate casting with auto-generation of risers
- Guide manufacturing engineers to refine process

Increase Manufacturing Quality and Profitability

- Quickly evaluate casting complexity for quoting
- Predict common casting defects upfront
- Optimize running and feeding systems
- Avoid expensive trial and error

Minimal Training with Maximum Benefit

By focusing on ease of use and managing all complexities in the background, Altair Inspire Cast eliminates the costly and time consuming training that most other casting simulation software generally requires.

Altair Inspire Cast is available for:





Windows 10, 8.1, 7

Supported Languages

Chinese	Japanese
English	Korean
French	Portuguese
German	Spanish
Italian	

Learn more at
altair.com/InspireCast

 forum.solidthinking.com
 youtube.com/InnovationSimulation

 facebook.com/altairengineering
 twitter.com/Altair_US



© 2018 Altair Engineering Inc. All Rights Reserved.
All other trademarks are properties of their respective owners.